



Product Summary

$V_{(BR)DSS}$	$R_{DS(on)TYP}$	I_D
60V	70mΩ@10V	3A
	82mΩ@4.5V	

Feature

- High power and current handing capability
- Surface mount package

Application

- Battery Switch
- DC/DC Converter

MARKING:

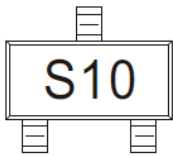

SOT-23

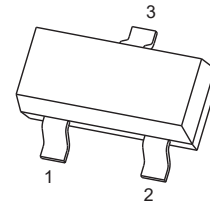

1. GATE
2. SOURCE
3. DRAIN

Schematic diagram

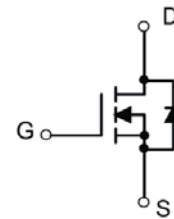

ABSOLUTE MAXIMUM RATINGS ($T_A=25^{\circ}C$ unless otherwise noted)

Parameter	Symbol	Value	Unit
Drain - Source Voltage	V_{DS}	60	V
Gate - Source Voltage	V_{GS}	±20	V
Continuous Drain Current ^{1,5}	I_D	3	A
Pulsed Drain Current ²	I_{DM}	10	A
Power Dissipation ^{4,5}	P_D	1.5	W
Thermal Resistance from Junction to Ambient ⁵	$R_{\theta JA}$	83.3	°C/W
Junction and Storage Temperature Range	T_J, T_{STG}	-55~ +150	°C

MOSFET ELECTRICAL CHARACTERISTICS ($T_a=25^\circ\text{C}$ unless otherwise noted)

Parameter	Symbol	Test Condition	Min	Type	Max	Unit
STATIC CHARACTERISTICS						
Drain-Source Breakdown Voltage	$V_{(BR)DSS}$	$V_{GS} = 0V, I_D = 250\mu A$	60			V
Zero Gate Voltage Drain Current	I_{DSS}	$V_{DS} = 60V, V_{GS} = 0V$			1	μA
Gate-Body Leakage Current	I_{GSS}	$V_{GS} = \pm 20V, V_{DS} = 0V$			± 100	nA
Gate Threshold Voltage ³	$V_{GS(th)}$	$V_{DS} = V_{GS}, I_D = 250\mu A$	0.5	1.2	2	V
Drain-Source On-Resistance ³	$R_{DS(on)}$	$V_{GS} = 10V, I_D = 3A$		70	90	m Ω
		$V_{GS} = 4.5V, I_D = 3A$		82	123	
Forward Transconductance ³	g_{FS}	$V_{DS} = 15V, I_D = 2A$	1.4	2.5		S
DYNAMIC CHARACTERISTICS						
Input Capacitance	C_{iss}	$V_{DS} = 30V, V_{GS} = 0V, f = 1MHz$		250		pF
Output Capacitance	C_{oss}			26		
Reverse Transfer Capacitance	C_{rss}			20		
SWITCHING CHARACTERISTICS						
Total Gate Charge	Q_g	$V_{DS} = 30V, V_{GS} = 4.5V, I_D = 3A$		7		nC
Gate-Source Charge	Q_{gs}			1.2		
Gate-Drain Charge	Q_{gd}			1.5		
Turn-On Delay Time	$t_{d(on)}$	$V_{GS} = 10V, V_{DD} = 30V, I_D = 1.5A, R_{GEN} = 1\Omega$		6.5		ns
Turn-On Rise Time	t_r			15.2		
Turn-Off Delay Time	$t_{d(off)}$			15.2		
Turn-Off Fall Time	t_f			10.3		
Source-Drain Diode characteristics³						
Body Diode Voltage	V_{SD}	$I_S = 3A, V_{GS} = 0V$		0.8	1.2	V

Notes :

1. The maximum current rating is limited by package.
2. Pulse Test : Pulse Width $\leq 10\mu s$, duty cycle $\leq 1\%$.
3. Pulse Test : Pulse Width $\leq 300\mu s$, duty cycle $\leq 2\%$.
4. The power dissipation P_D is limited by $T_{J(MAX)} = 150^\circ\text{C}$.
5. Device mounted on $1in^2$ FR-4 board with 2oz. Copper, in a still air environment with $T_A = 25^\circ\text{C}$.

Typical Characteristics

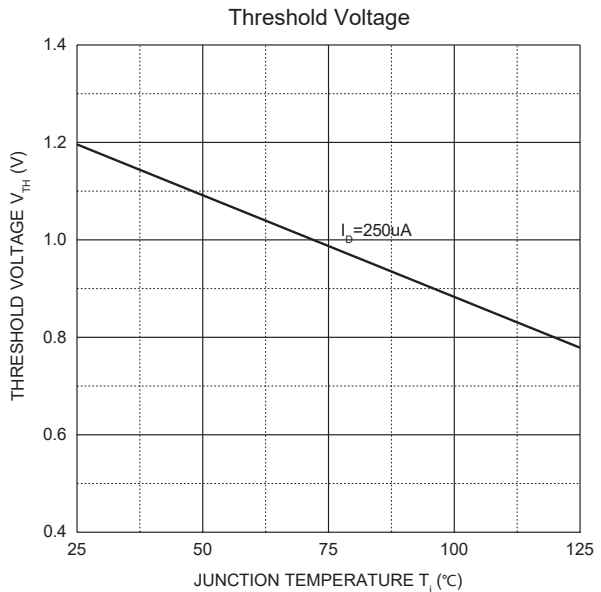
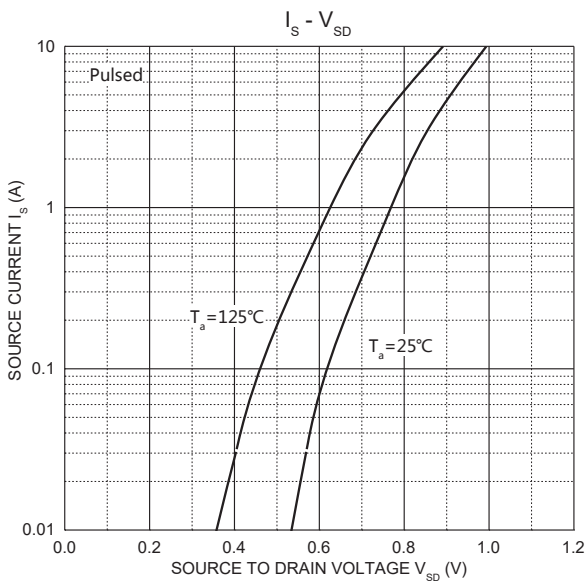
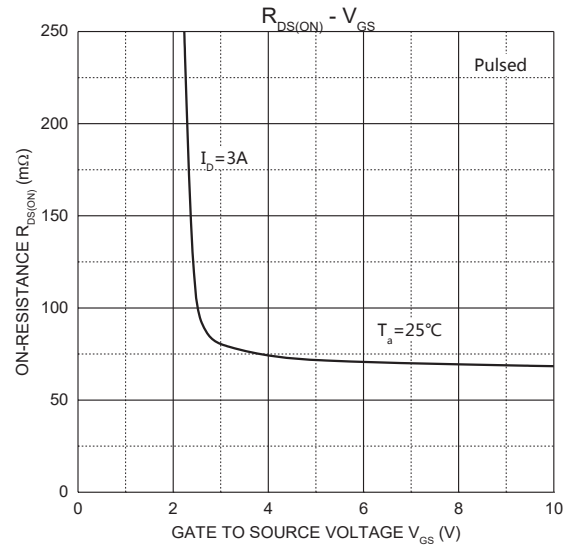
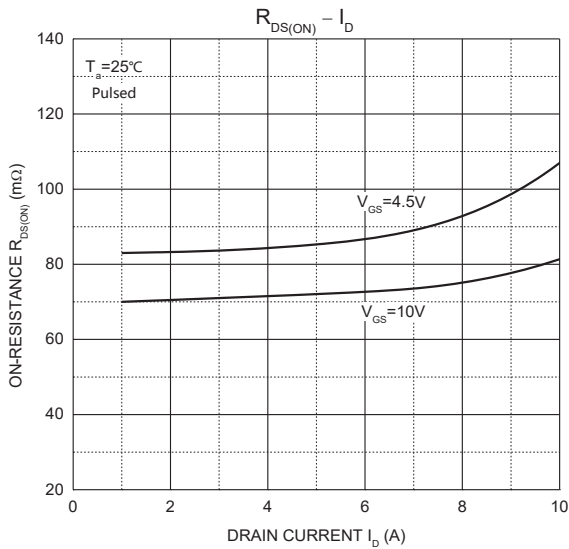
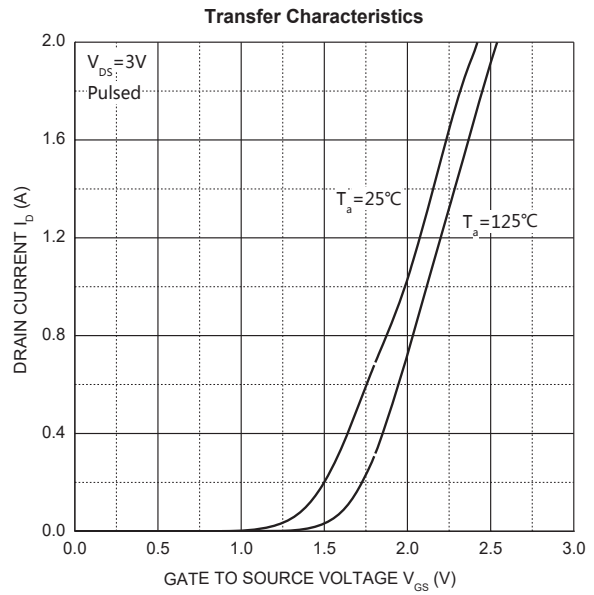
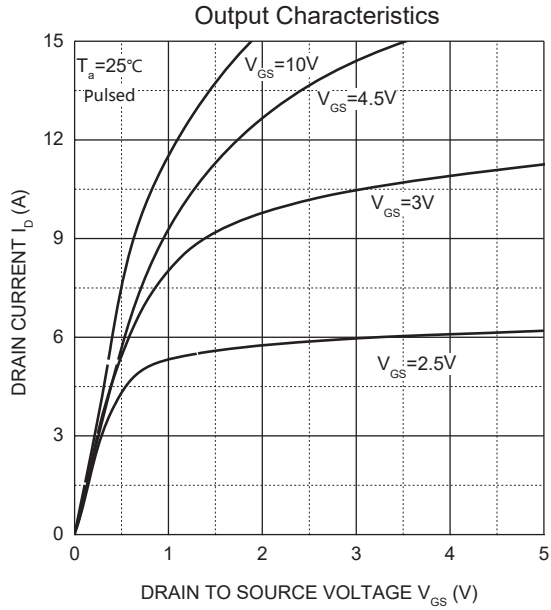

SOT-23 Package Information

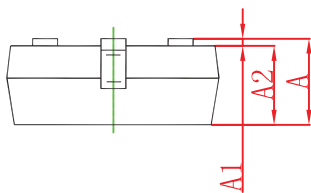
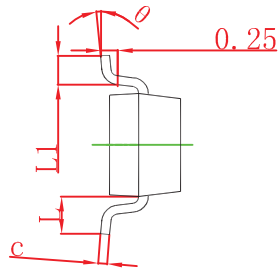
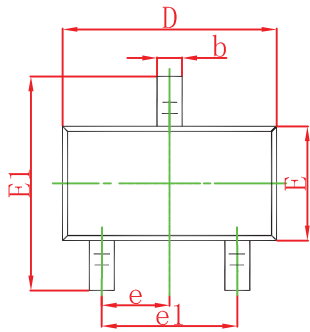

Symbol	Dimensions In Millimeters		Dimensions In Inches	
	Min	Max	Min	Max
A	0.900	1.150	0.035	0.045
A1	0.000	0.100	0.000	0.004
A2	0.900	1.050	0.035	0.041
b	0.300	0.500	0.012	0.020
c	0.080	0.150	0.003	0.006
D	2.800	3.000	0.110	0.118
E	1.200	1.400	0.047	0.055
E1	2.250	2.550	0.089	0.100
e	0.950 TYP		0.037 TYP	
e1	1.800	2.000	0.071	0.079
L	0.550 REF		0.022 REF	
L1	0.300	0.500	0.012	0.020
θ	0°	8°	0°	8°

SOT-23 Tape and reel

SOT-23 Embossed Carrier Tape

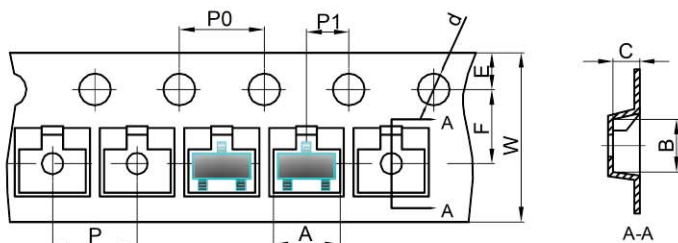

Dimensions are in millimeter										
Pkg type	A	B	C	d	E	F	P0	P	P1	W
SOT-23	3.15	2.77	1.22	Ø1.50	1.75	3.50	4.00	4.00	2.00	8.00

SOT-23 Tape Leader and Trailer

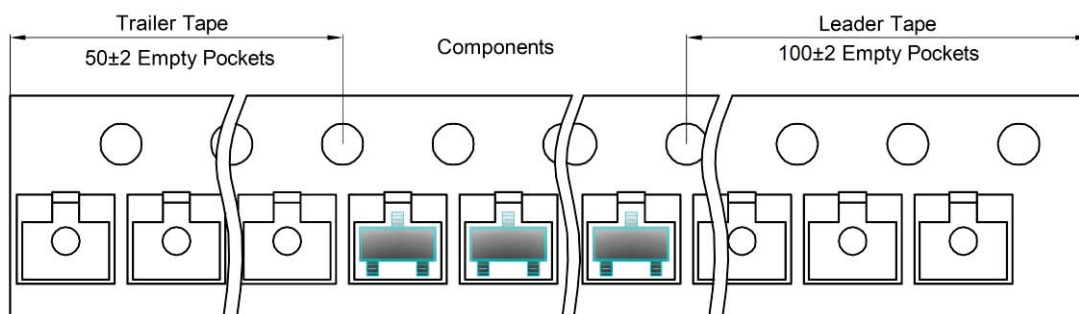

SOT-23 Reel

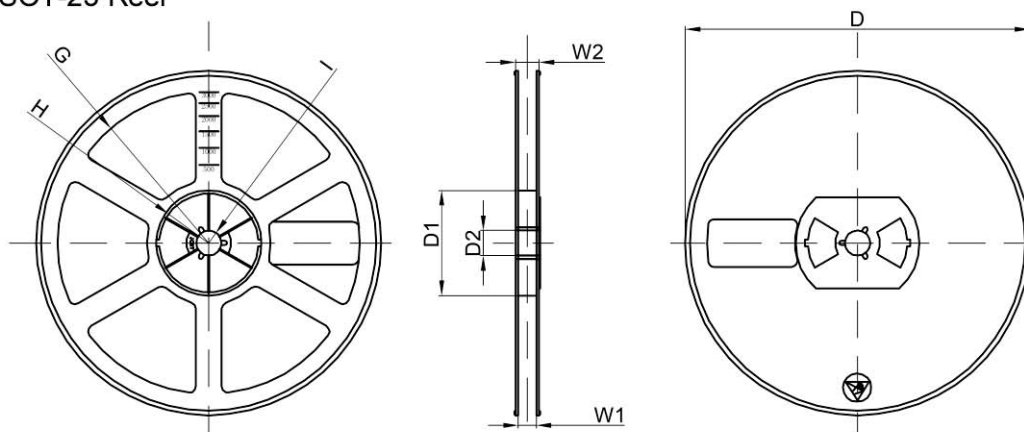

Dimensions are in millimeter								
Reel Option	D	D1	D2	G	H	I	W1	W2
7" Dia	Ø178.00	54.40	13.00	R78.00	R25.60	R6.50	9.50	12.30

REEL	Reel Size	Box	Box Size(mm)	Carton	Carton Size(mm)	G.W.(kg)
3000 pcs	7 inch	30,000 pcs	203×203×195	120,000 pcs	438×438×220	